

GAB 1000

Turbidity transmitter
From 0.1 to 1000 FNU



INSTRUCTION MANUAL

BAMO MESURES

22, Rue de la Voie des Bans - Z.I. de la Gare - 95100 ARGENTEUIL

Tél : (+33) 01 30 25 83 20 - Web : www.bamo.fr

Fax : (+33) 01 34 10 16 05 - E-mail : info@bamo.fr

Turbidity transmitter

GAB 1000

04-11-2009

446 M1 02 D

MES

446-02/1

SAFETY PRECAUTIONS

Only qualified person should operate, install and assure the maintenance.
All International and European recommendations on electrical installation should be applied.

- The device may only be connected to supply power, which complies with the specifications included in the technical data!
- The device must be disconnected from all sources of power during installation and maintenance work!
- The device may only be operated under the conditions specified in the operating instructions!

FUNCTIONS - DESCRIPTION

The turbidity-measuring device determines the turbidity of liquids using the light absorption and scattered light measuring method. The inline measuring cell at the sensor set makes use of two IR transmitters and one IR receiver in pulsating light mode (IR measuring method according to ISO 7027). The interconnected BAMOPHOX TUR measuring amplifier (option) analyses the 4 to 20 mA signal generated by the sensor set.

MOUNTING

- The fixture must be installed **vertically!** – Best installation is the mounting in an ascending tube with slow down section 600 mm in front and 400 mm behind the turbidity-measuring device.
- The sensor fixture must be completely filled with liquid during the performance of measurements.
Install to the vertical portion of a siphon trap if necessary.
- Air bubbles distort measurement results.
- Glass windows must be clean – clean them at regular intervals as required.

SET UP – DISPLAYS

The sensor set consists of a receiver module with microprocessor-controlled analysis electronics and two emitter modules. The sensor set generates a 4 to 20 mA output signal in accordance with the following diagram. Measuring ranges are selected with the help of the DIP switches on the receiver module.

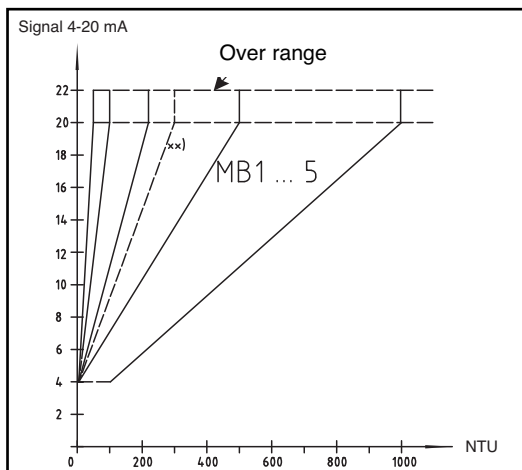

Note: The turbidity measuring instruments are calibrated with the internationally specified standard suspension Formazin.

The indication takes place thus not in form of the measured light intensity, but as concentration of the Formazin calibration suspension.

During the measurement with any liquid, this means thus that the liquid concerned causes the same light scattering as the standard suspension of the indicated concentration.

Measured values of other turbidity measuring instruments, which use other calibration suspensions and measuring angle, cannot be compared directly with those with Formazin calibrated measuring instruments.

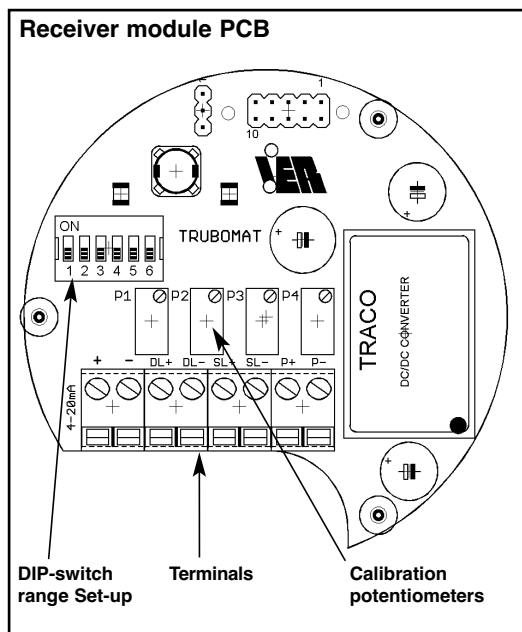

Measuring range	DIP1	DIP2	DIP3	DIP4	DIP5*	DIP6*
MB1 = 0,1... 50 FNU	OFF	OFF	OFF	ON	NC	NC
MB2 = 0,1...100 FNU	ON	OFF	OFF	ON	NC	NC
MB3 = 0,1...200 FNU	OFF	ON	OFF	ON	NC	NC
MB4 = 0,1...500 FNU (**300)	ON	ON	OFF	ON	NC	NC
MB5 = 100...1000 FNU	OFF	OFF	OFF	OFF	NC	NC

*) DIP5 and 6 = not connected / no function

**) Armatures with nominal diameter > DN 60 - DN 100

	Indication
Green LED = 1Hz blinking	Ready, measuring in operation
Green LED = permanent ON	Ready, measuring not in operation
Green LED = OFF	No power supply, or defective

	Fault indication
Red LED = ON	Measuring circuit faulty, (short circuit, or broken) (court circuit ou rupture)

Signal in limit conditions:

- 0 mA = wrong connected and / or dip-switches wrong adjusted
- 4 mA = 0 FNU (clearest water, pipe filled)
- 20 mA = 100% output acc. to adjusted range (pipe filled)
- 22 mA = over range
- 21 mA = general failure on electronics

When pipe is empty:

- if there are no water drops on the glasses the output will be a little bit higher than 4 mA (depending on the refraction index of air-molecules).
- if there are water drops on the glasses the output is higher than 4 mA, but the signal depends on size and quantity of water drops.

So it's important to install the turbidity measurement system always in such a way that the pipe is filled at any time (vertically or with a siphon). That's valid not only for TURBICUBE but for all systems on the market.

WIRING

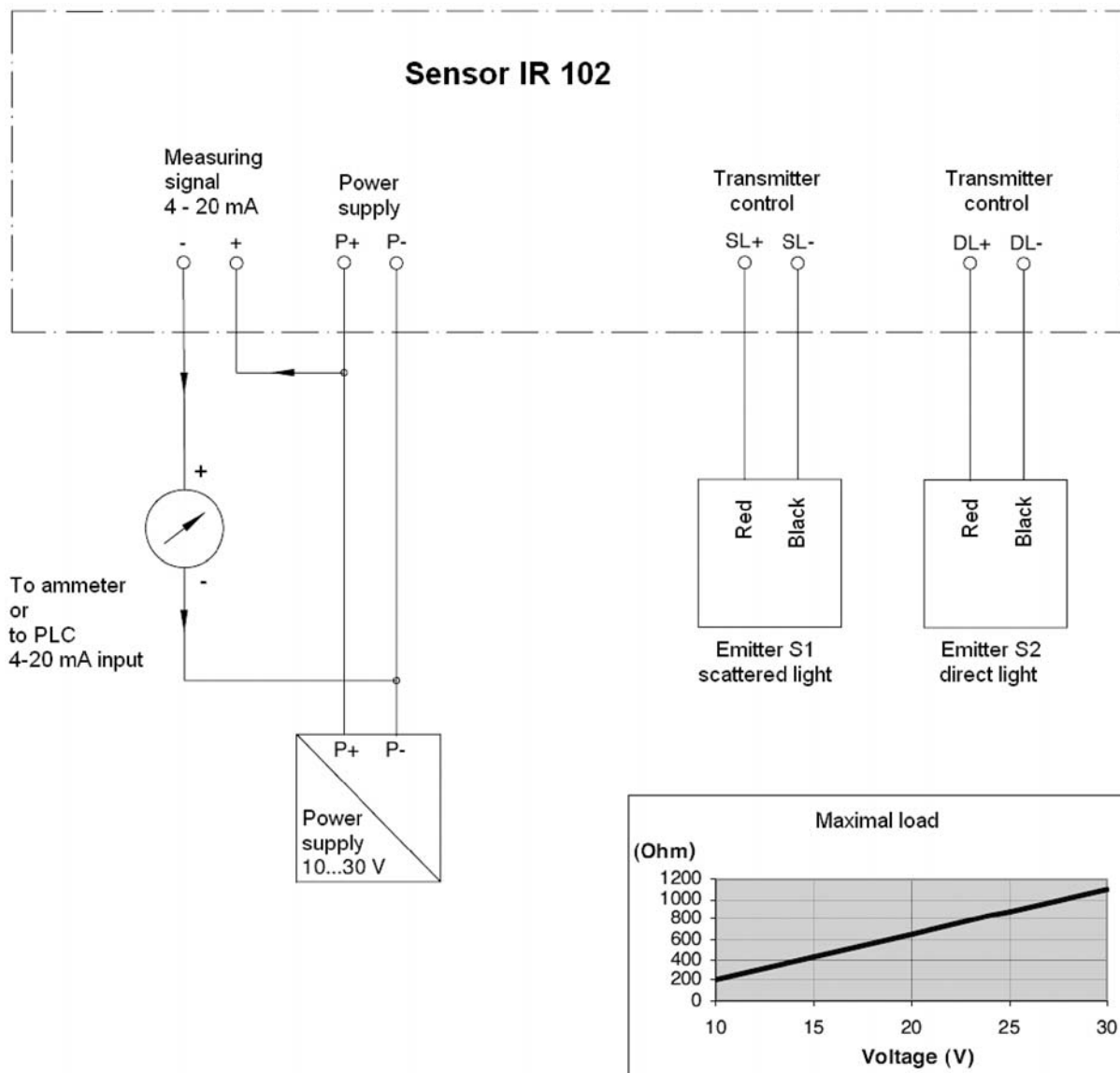

NOTE:

The measuring output "4-20 mA" is a current drain, this means, the output channel has the same electrical behaviour as a variable resistor.

An active power supply for the measuring circuit is always needed.

For connection to BAMOPHOX TUR, please see specific documentation msa436-01.

MAINTENANCE

Cleaning intervals depend upon the type of liquid medium and must be determined by the user.

Cleaning the lenses:

- Disconnect the turbidity-measuring instrument from all sources of power.
- Depressurize pipes and empty liquid medium from the device.
- Remove the transmitters and the receiver from the fixture by unscrewing the sleeve nuts.

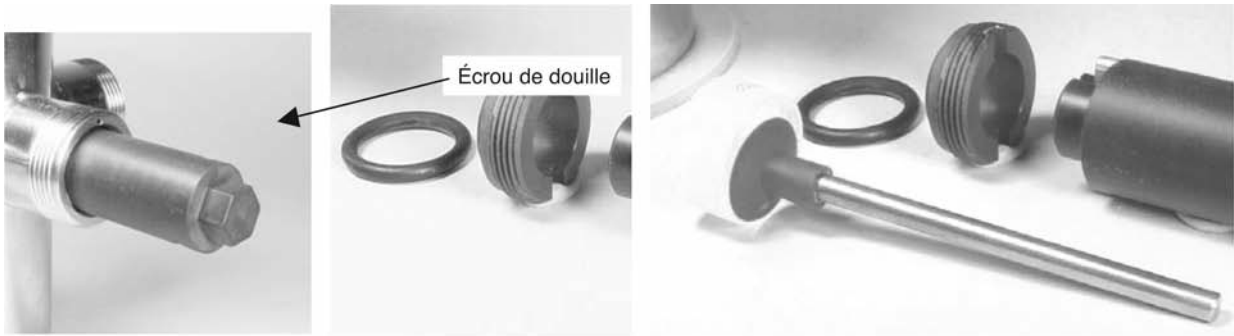

1) Screw the compression disc with the included tool and remove it.

2) Remove the O-ring.

3) Remove the lens with the included suction cup, and clean the lens.

Do not use abrasive cleansers

Reassemble after cleaning by following the above instructions in reverse.

Note:

- Inspect the O-ring before reassembly and replace it if necessary.
- Tighten the compression disc with the included tool (use the rod of the suction cup as a lever).
- Before reinstalling the transmitters and the receiver, refill the fixture with liquid medium and inspect for possible leaks.



Observe the positioning of hole and pin!

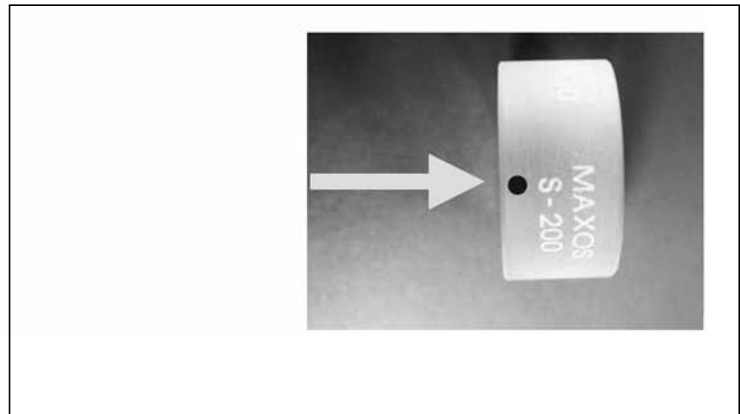

Note for cold fluids:

- The fixture has to be installed to the pipeline with mounted sensors only.
- For cleaning the glasses, dismantle the complete fixture, after cleaning install as described above

CALIBRATION

Factory Calibration

The sensor set is equipped with a calibration constant as a design feature. As a rule, no recalibration is required. Calibration point accuracy is better than 2%, and drift is less than 1% per year.



Test Equipment Monitoring

If device calibration testing is required as part of the respective quality assurance system for test equipment monitoring, calibration can be checked with the calibration rods, and the device can be readjusted if necessary. A suitable calibration standard is delivered with each turbidity-measuring instrument. Each calibration standard is matched to the specific circumstances of the mating turbidity-measuring instrument and cannot be used for other measuring instruments of the same type!

The calibration standard and the turbidity-measuring instrument must have the same serial number!

Caution:

It must be assured that all utilised control and switching devices are switched off during recalibration!

The following adjustment sequence must be adhered to!

1. Clean all lenses and wipe them dry (all visible water droplets and water film must be removed!).
2. Then reinstall the lenses for the receiver and the S1 transmitter only.
Do not yet install the lens and the compression disc for the S2 transmitter (180° scattered light)
3. Reinstall the S1 transmitter and the receiver.
4. Remove the KN-D calibration rod from the box.
5. Insert the calibration rod into the fixture
6. Mount the S2 transmitter to the calibration rod (observe the locking pin)

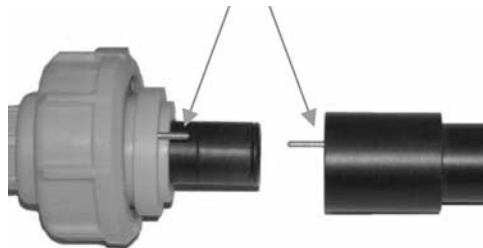

7. Insert the calibration rod with attached transmitter completely into the fixture (observe the locking pin), and tighten the sleeve nut.
8. Set the DIP switches to the MB5 range = 100 to 1000 FNU (DIP 1, 2, 3, and 4 are OFF)
9. Switch supply power back on again – the status LED blinks!
10. Compare the set point value and the actual value.
Set point 1 (SW1) = set point on the plate in the box of the KN-D calibration rod
Actual value = measured value
11. Set point vs. actual value deviation:
Less than $\pm 5\%$, measuring instrument is OK
Greater than $\pm 5\%$, adjust actual value with potentiometer P3
12. Remove transmitter and calibration rod KN-D
13. Remove the KN-S calibration rod (scattered light) from the box.
14. Mount the calibration rod to the S2 transmitter as described above.
15. DIP switches stay on the MB5 range = 100 to 1000 (all switches off).
16. Switch the power ON if not yet ready.

17. Compare the set point value and the actual value.
Set point 2 (SW2) = set point on the plate in the box of the KN-S calibration rod
Actual value = measured value
18. Set point vs. actual value deviation:
Less than $\pm 5\%$, measuring instrument is OK
Greater than $\pm 5\%$, adjust actual value with potentiometer P2
19. Set the DIP switches to the MB4 range = 0.1 to 500 (DIP 1, 2 and 4 are ON — DIP 3 is OFF)
20. Compare the set point value and the actual value.
Set point 3 (SW3) = set point on the plate in the box of the KN-D calibration rod
Actual value = measured value
21. Set point / actual value deviation:
Less than $\pm 5\%$ __ measuring instrument is OK
Greater than $\pm 5\%$ __ adjust actual value with potentiometer P4
22. Remove the KN-S calibration rod.
23. Mount glass with sealing ring and compression disc and transmitter S2
24. Select the right DIP-switch setting for operation

TECHNICAL FEATURES

Terminal housing:	PBT, IP65
Power supply:	10...30 V DC
Power consumption:	0.6 W
Output signal:	4-20 mA
Ambient temperature:	+ 5...+ 45°C
Process temperature:	+ 5...+ 60°C
Accuracy:	$\pm 5\%$ reading, $\pm 1\%$ full scale (in use)
Maximum pressure:	10 bar as a maximum at 60°C
Status indication:	green LED = correct red LED = failure
Selectable ranges:	0.1 to 50 FNU, 0.1 to 100 FNU, 0.1 to 200 FNU, 0.1 to 500 (or 0.1 to 300*) FNU, 100 to 1000 FNU * fittings DN80 & DN100
Material:	Stainless steel body
Process connections:	Flanges PN10 (DIN 2501) Triclamp DIN 32676)
CE mark:	In accordance with low-voltage directive (73/23/EWG) and EWG directive (89/336) and EN 50 082-2: 995; EN 55 011 (Classe A): 1998

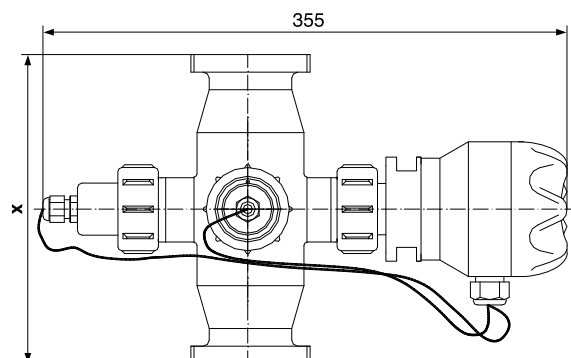

DN 65/25	X = 288
DN 65/32	X = 266
DN 65/40	X = 244
DN 65/50	X = 202
DN 65/65	X = 249
DN 100/80	X = on request
DN 100/100	X = on request